

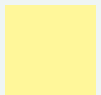

weiss  
(Standard)



3000°K



4000°K

## LED Einbau-Downlights

750 lm - 3.000 lm

Ø 130mm, 190mm & 240mm

LED Downlight-Serie ‚SPMI‘ für weiches, gestreutes Licht. Das Gehäuse besteht aus Aluminium, matt weiß beschichtet. Als Abdeckung dient opales Glas.

Farben:

- erhältlich in der Farbe weiß

Versionen:

- Ø 130mm
- Ø 190mm
- Ø 240mm

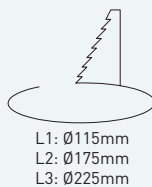
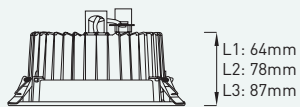
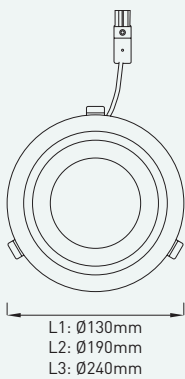

SPMI

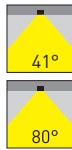

Artikelnummer ZLED-	Durchmesser	Lichtfarbe Kelvin	Lumen	Leistung System	Abstrahl- winkel	Gewicht
<b>SPMI - nicht dimmbar</b>						
600SPI52830008W	130mm	3000°K	750 lm	8W	41°	0,7kg
600SPI52840008W	130mm	4000°K	750 lm	8W	41°	0,7kg
600SPI52830010W	190mm	3000°K	1.000 lm	10W	41°	1,0kg
600SPI52840010W	190mm	4000°K	1.000 lm	10W	41°	1,0kg
600SPI52830015W	240mm	3000°K	1.500 lm	15W	80°	2,0kg
600SPI52840015W	240mm	4000°K	1.500 lm	15W	80°	2,0kg
600SPI52830020W	240mm	3000°K	2.100 lm	20W	80°	2,0kg
600SPI52840020W	240mm	4000°K	2.100 lm	20W	80°	2,0kg
600SPI52830028W	240mm	3000°K	3.000 lm	28W	80°	2,0kg
600SPI52840028W	240mm	4000°K	3.000 lm	28W	80°	2,0kg
<b>SPMI - DALI dimmbar</b>						
600SPI59830008W	130mm	3000°K	750 lm	8W	41°	0,7kg
600SPI59840008W	130mm	4000°K	750 lm	8W	41°	0,7kg
600SPI59830010W	190mm	3000°K	1.000 lm	10W	41°	1,0kg
600SPI59840010W	190mm	4000°K	1.000 lm	10W	41°	1,0kg
600SPI59830015W	240mm	3000°K	1.500 lm	15W	80°	2,0kg
600SPI59840015W	240mm	4000°K	1.500 lm	15W	80°	2,0kg
600SPI59830020W	240mm	3000°K	2.100 lm	20W	80°	2,0kg
600SPI59840020W	240mm	4000°K	2.100 lm	20W	80°	2,0kg
600SPI59830028W	240mm	3000°K	3.000 lm	28W	80°	2,0kg
600SPI59840028W	240mm	4000°K	3.000 lm	28W	80°	2,0kg

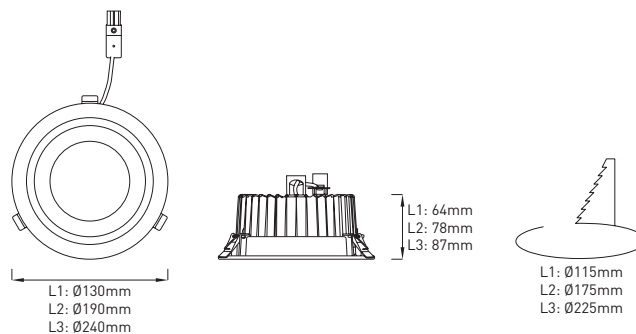

SPMI 130mm  
8W 41°:

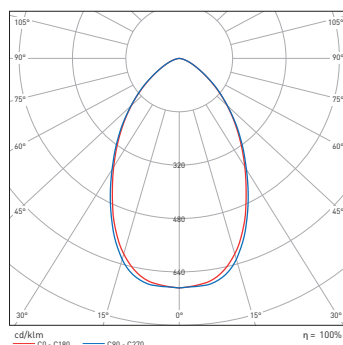

SPMI 240mm  
20W 80°:

