

# NEPTUN AC Surface

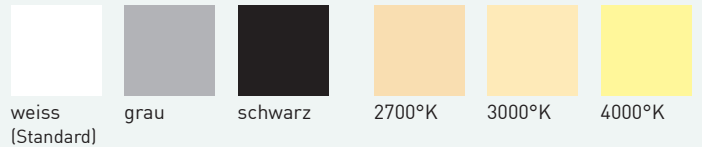
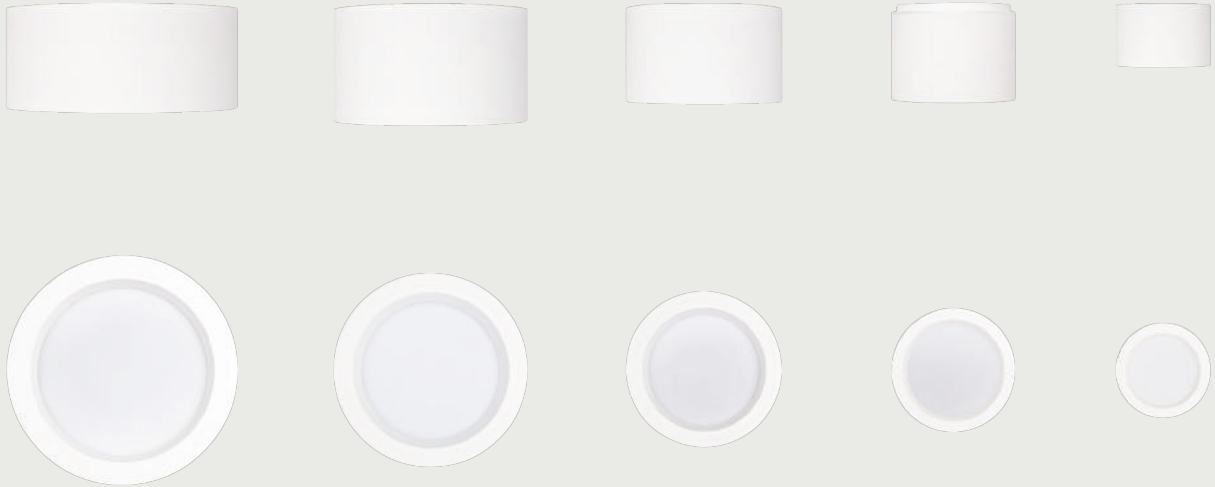

## LED Anbau-Downlights

410 lm - 2.515 lm

Ø 100mm, 140mm, 190mm, 210mm & 230mm

LED Downlight-Serie ‚NEPTUN AC Surface‘, für die Anbaumontage in fünf verschiedenen Größen und Leistungsstärken.

Farben:

- Gehäuse aus Aluminium-Druckguss, erhältlich in den Farben weiß (Standard), grau & schwarz.

Erhältliche Größen:

- **Neptun AC Mini:** Ø 100mm x H 47mm
- **Neptun AC Midi:** Ø 140mm x H 65mm
- **Neptun AC Std:** Ø 190mm x H 90mm
- **Neptun AC Maxi:** Ø 210mm x H 100mm
- **Neptun AC Mega:** Ø 230mm x H 72mm

Auf Anfrage erhältlich:

- Ausführung in DALI dimmbar.
- in der Lichtfarbe 5000°K (CRI ≥ 80)

Spannung: 220-240V / 50-60Hz

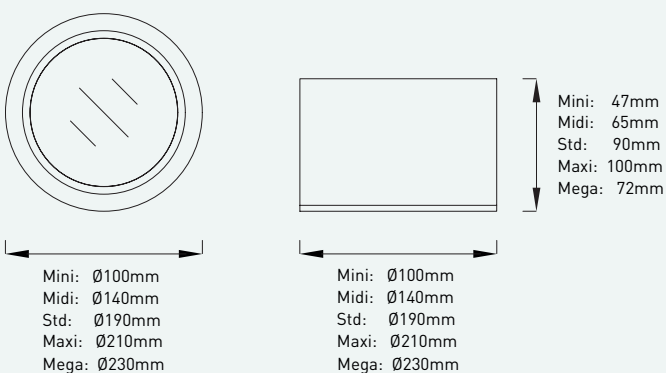

## NEPTUN AC Mini Surface | Ø100mm



Artikelnummer ZLED-	Gehäusefarbe	Lichtfarbe Kelvin	Lumen	Leistung LED	Leistung System	Abstrahlwinkel
650NEP10082052W	weiss	2700°K	410 lm	4W	5W	104°
650NEP10083052W	weiss	3000°K	422 lm	4W	5W	104°
650NEP10084052W	weiss	4000°K	448 lm	4W	5W	104°

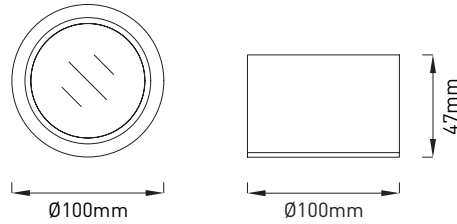

## NEPTUN AC Midi Surface | Ø140mm



Artikelnummer ZLED-	Gehäusefarbe	Lichtfarbe Kelvin	Lumen	Leistung LED	Leistung System	Abstrahlwinkel
650NEP14082102W	weiss	2700°K	848 lm	8W	10W	108°
650NEP14083102W	weiss	3000°K	873 lm	8W	10W	108°
650NEP14084102W	weiss	4000°K	927 lm	8W	10W	108°

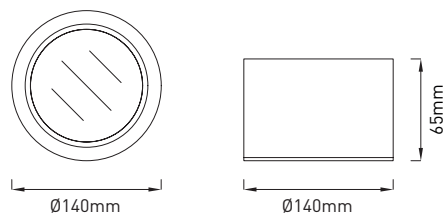

## Sonstiges:

- Toleranzen der angeführten Werte (Strom & Lumen): ± 7,5%
- Auf Anfrage auch in der Lichtfarbe 5000°K erhältlich



Leuchten in DALI dimmbar auf Anfrage bzw. Bestellung erhältlich!



NEPTUN AC Mini 5W 4000°K:

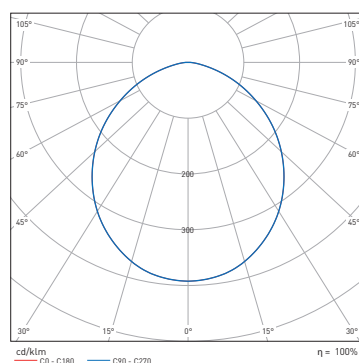

NEPTUN AC Midi 10W 4000°K:

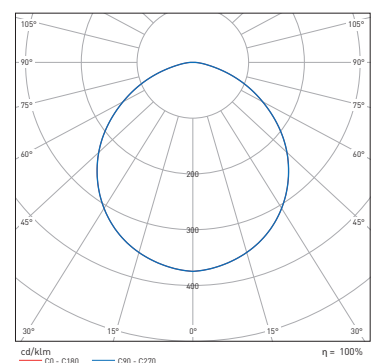

# NEPTUN AC Surface



## NEPTUN AC STD Surface | Ø190mm

Artikelnummer ZLED-	Gehäusefarbe	Lichtfarbe Kelvin	Lumen	Leistung LED	Leistung System	Abstrahlwinkel
650NEP19082152W	weiss	2700°K	1.300 lm	13W	15W	105°
650NEP19083152W	weiss	3000°K	1.340 lm	13W	15W	105°
650NEP19084152W	weiss	4000°K	1.420 lm	13W	15W	105°

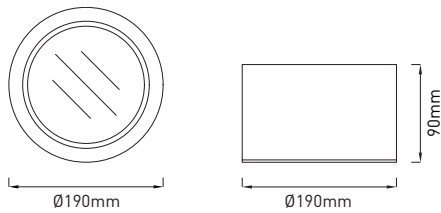

## NEPTUN AC Maxi Surface | Ø210mm

Artikelnummer ZLED-	Gehäusefarbe	Lichtfarbe Kelvin	Lumen	Leistung LED	Leistung System	Abstrahlwinkel
650NEP21082202W	weiss	2700°K	1.675 lm	18W	20W	103°
650NEP21083202W	weiss	3000°K	1.725 lm	18W	20W	103°
650NEP21084202W	weiss	4000°K	1.830 lm	18W	20W	103°

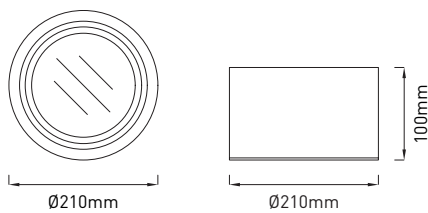

NEPTUN AC STD 15W 4000°K:

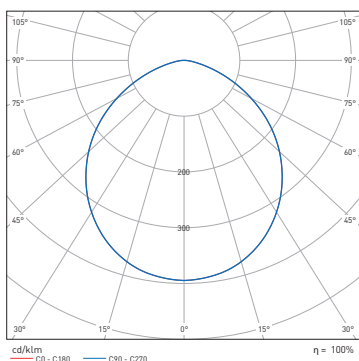

NEPTUN AC Maxi 20W 4000°K:

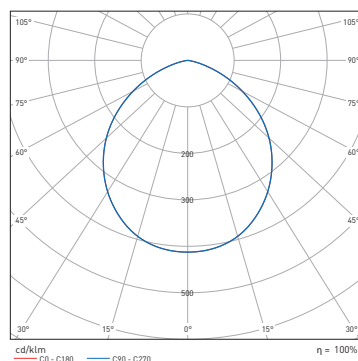

**Sonstiges:**

- Toleranzen der angeführten Werte (Strom & Lumen): ± 7,5%
- Auf Anfrage auch in der Lichtfarbe 5000°K erhältlich



Leuchten in DALI dimmbar auf Anfrage bzw. Bestellung erhältlich!



## NEPTUN AC Mega Surface | Ø230mm



Artikelnummer ZLED-	Gehäusefarbe	Lichtfarbe Kelvin	Lumen	Leistung LED	Leistung System	Abstrahl- winkel
650NEP23082252W	weiss	2700°K	2.300 lm	23W	25W	108°
650NEP23083252W	weiss	3000°K	2.370 lm	23W	25W	108°
650NEP23084252W	weiss	4000°K	2.515 lm	23W	25W	108°

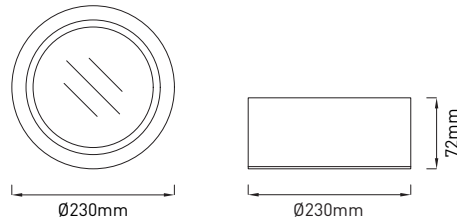

## Sonstiges:

- Toleranzen der angeführten Werte (Strom & Lumen): ± 7,5%
- Auf Anfrage auch in der Lichtfarbe 5000°K erhältlich

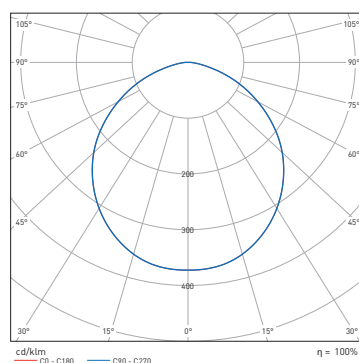

Leuchten in DALI dimmbar  
auf Anfrage bzw. Bestellung  
erhältlich!

NEPTUN AC  
Mega 20W  
4000°K:

Abstand [m]	Kegeldurchmesser [m]	Beleuchtungsstärke [lx]
0.50	1.4	E10° E100° 3748 E100° 382
1.0	2.8	E10° E100° 937 E100° 95
1.5	4.1	E10° E100° 416 E100° 42
2.0	5.5	E10° E100° 234 E100° 24
2.5	6.9	E10° E100° 150 E100° 15
3.0	8.3	E10° E100° 104 E100° 11

Abstand [m]    Kegeldurchmesser [m]    Beleuchtungsstärke [lx]  
C0 - C180 (Halbstrahlwinkel: 108.0°)