

dunkel-
grau



schwarz
(Standard)



4000°K

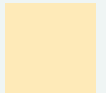

5000°K

LED Einbau-Tiefstrahler IP65

15.744 lm - 28.150 lm

LED Einbau-Tiefstrahler-Serie ‚Asteroid‘, konzipiert als Ersatz für herkömmliche Tiefstrahler von 135W und 232W.

Gehäuse aus korrosionsbeständigem Aluminiumdruckguss in schwarz (Standard). Auf Anfrage auch in dunkelgrau erhältlich.

Erhältlich mit dem Abstrahlwinkel:

- 60°/90°/120° (Standard: 90°)

Auf Anfrage erhältlich:

- Mit Lichtfarbe 3.000°K

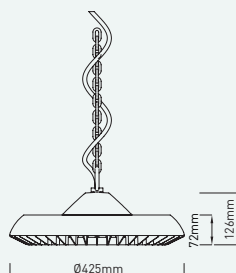
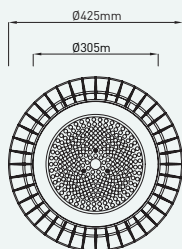
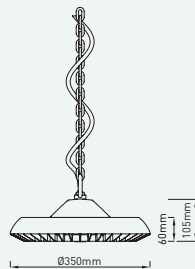
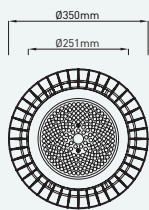

ASTEROID MINI

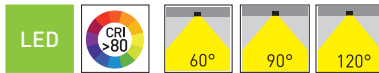

Artikelnummer ZLED-	Type	Lichtfarbe Kelvin	Lumen	Leistung LED	Leistung System	Gewicht
710AST92840135B	MINI	4000°K	15.744 lm	130W	135W	5,0kg
710AST92850135B	MINI	5000°K	16.530 lm			

Auf Anfrage/Bestellung erhältlich in der Farbe hellgrau oder dunkelgrau. Standard: schwarz
Auf Anfrage mit Lichtfarbe 3000°K lieferbar.

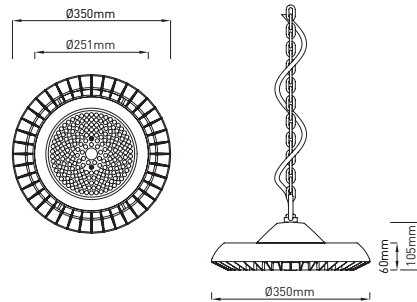

Allgemeines:

- Montagehöhe: 4-10m
- Gewicht: 5,0kg

ASTEROID MAXI

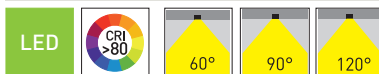

Artikelnummer ZLED-	Type	Lichtfarbe Kelvin	Lumen	Leistung LED	Leistung System	Gewicht
710AST92840230B	MAXI	4000°K	26.819 lm	225W	232W	7,4kg
710AST92850230B	MAXI	5000°K	28.150 lm			

Auf Anfrage/Bestellung erhältlich in der Farbe hellgrau oder dunkelgrau. Standard: schwarz
Auf Anfrage mit Lichtfarbe 3000°K lieferbar.

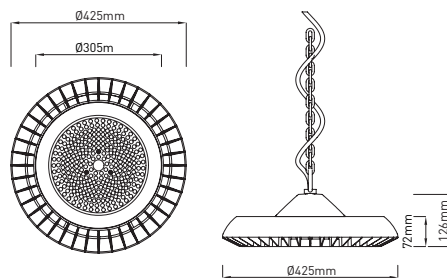

Allgemeines:

- Montagehöhe: 6-12m
- Gewicht: 7,4kg

Sonstiges:

- Anschluss an: 220/240V - 50/60Hz
- Toleranzen der angeführten Werte (Strom & Lumen): ± 7,5%

