



schwarz



4000°K



5700°K

LED Highbay / Tiefstrahler

11.700 lm - 27.000 lm

LED Tiefstrahler-Serie ‚OST‘, symmetrisch breitstrahlend.

Gehäuse aus Metall in schwarz beschichtet mit klarer Abdeckung aus Polycarbonat (PC) und justierbaren Befestigungsbügel.

Erhältliche Ausführungen:

- OST 4LED: 11.700lm (87W)
- OST 8LED: 18.600lm (118W)
27.000lm (179W)

Zubehör:

- als Zubehör ist ein Befestigungsrahmen für die Befestigung von 4 Stück OST 4LED erhältlich.

Auf Anfrage erhältlich:

- Ausführung in DALI dimmbar

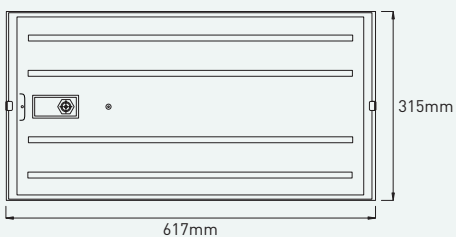
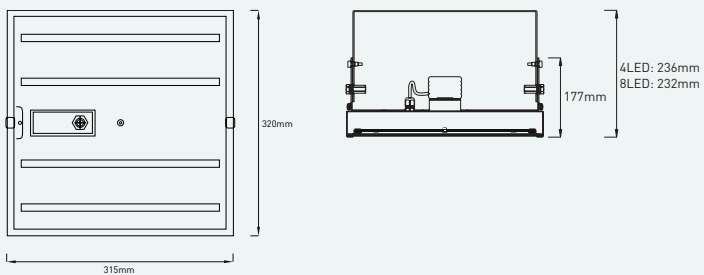

OST 4LED | OST 8LED



Artikelnummer ZLED-	Type	L x B	Lichtfarbe Kelvin	Lumen LED	Leistung System	Gewicht
7100ST6522842W	OST 4LED	315 x 320mm	4000°K	11.700 lm	87W	6,0kg
7100ST6522852W	OST 4LED	315 x 320mm	5700°K			
7100ST65	OST 8LED	617 x 315mm	4000°K	18.600 lm	118W	11,0kg
7100ST65	OST 8LED	617 x 315mm	5700°K			
7100ST6542842W	OST 8LED	617 x 315mm	4000°K	22.800 lm	174W	11,0kg
7100ST6542852W	OST 8LED	617 x 315mm	5700°K			

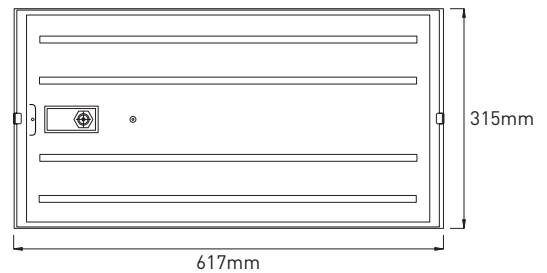
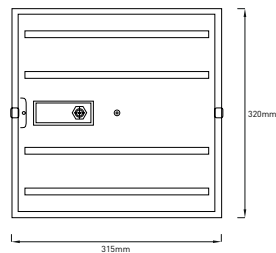
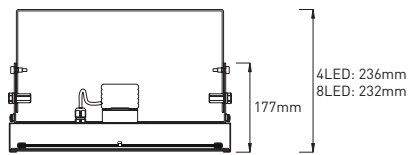

OST ZUBEHÖR

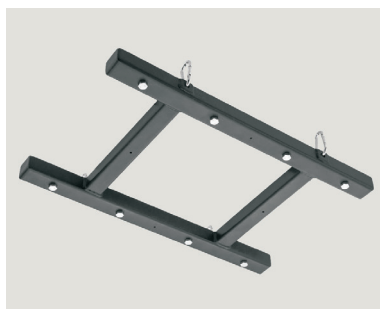

Artikelnummer ZLED-	Artikelbeschreibung	Gewicht
7100ST9900400B	Befestigungsbügel für 4 Stück OST 4LED schwarz	6,0kg

Befestigungsbügel bestückt:

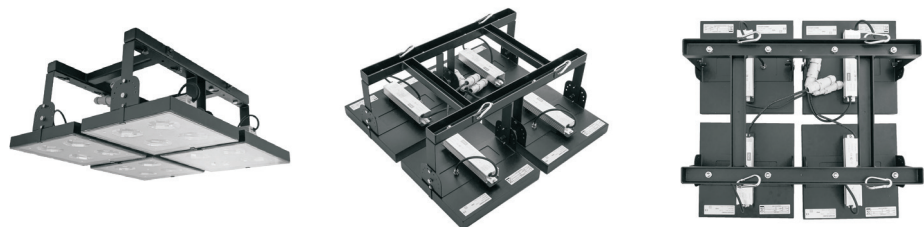

Allgemeine Hinweise:

- auf Anfrage in DALI dimmbar erhältlich.
- auf Anfrage/Sonderbestellung auch in engstrahlend erhältlich.
- Hohe Lebensdauer: 50.000 Stunden (gemäß L80B50)



OST 4LED
4000°K:

